



EASY CRIMPING, EASY WIN



Harmonious development for the future

ISO9001

WENZHOU HEWLEE TOOLS CO., LTD

ADD:NO.33 BADA ROAD, LINYANG DISTRICT, NANBIN STREET,

RUIAN CITY, ZHEJIANG PROVINCE, 325200, CHINA

Tel:+86-577-65597652 Whatsapp:+86 19588069282

E-mail:hewleetool@gmail.com,sales@hewlee.com

Http://www.hewlee.com



Catalog

Company Profile	02
Battery Crimping Tool	03
Battery Cable Cutter	09
Battery Pressing Tool	17
Electric Plug Crimping Tool Gun Type	21
Electric Plug Crimping Tool Table Type	27

Company Profile



Wenzhou HEWLEE Tools Co., Ltd. is a factory specializing in the development and sales of electric hydraulic tools, established in 2014. The products mainly involve battery hydraulic crimping tool, battery cable cutters, battery pressing tool, battery nut splitters and plug-in hydraulic tools, which are used in electric power and plumbing . We provide our customers with ideal solutions in terms of product innovation and specialized applications. Our products are sold in Southeast Asia, Europe, North America and other countries, the company has always adhered to the "quality of life, reputation as a pillar, and strive to create an international brand" guidelines. We are constantly striving to make "HEWLEE" brand full of globalization.



BATTERY POWERED CRIMPING TOOL

SERIES

HL-300B

BATTERY POWERED CRIMPING TOOL



- Head rotates 360°
- Manual retract button
- White LED illuminate work area
- Trigger switch
- Ergonomic design for one hand operation
- Li-ion battery with high capacity
- Low battery charges or lacking pressure, an acoustic signal sounds and LED flash

- 360° flip-top latch crimping head, working at any site
- Pistol type tool body design for better balance and easy handling
- Double Piston pump and powerful motor ensure quick crimp
- Automatically fully retract ram and stop motor when complete crimp
- Manually retract ram in case of need
- Li-ion battery with high capacity and require short charging time
- A temperature sensor makes the tool stop working automatically when the temperature over 60° under long time working

Model	HL-300B
Output Force:	60KN
Stroke:	17mm
Crimping range:	CU10-300mm ²
Battery:	18v DC 5.0Ah Li-ion
Charging time:	Approx. 2 hours
Voltage of charger:	110-240V AC
Crimping dies:	10,16,25,35,50,70,95,120,150,185,240,300mm ²
Machine weight:	4.0KG
Packing:	Plastic Case



HL-400B

BATTERY POWERED CRIMPING TOOL



- C-shape head can be rotate 360° to adapt to different working situations
- Good design cooling system can effectively prevent motor overheating
- One button operation is easy to use, automatic pressure relief
- Battery upgrade to 5.0AH, two batteries can work in turn
- Special suitcase is clean and tidy inside, it is easy to carry
- The dies are made of high strength alloy steel, after heat treatment, it is durable and beautiful
- Easy to carry by hand and tidy inside

Model	HL-400B
Output Force:	120KN
Stroke:	42mm
Crimping Range:	CU16-400mm ²
Battery:	18V DC 5.0Ah Li-ion
Charging time:	Approx. 2 hours
Voltage of charger:	110-240V AC
Crimping dies:	16,25,35,50,70,95,120,150,185, 240,300,400mm ²
Machine weight:	6.2KG
Packing:	Plastic Case

HL-630B

BATTERY POWERED CRIMPING TOOL



- H Type rotated head for easy dies installation and flexibile operation
- Good design cooling system can effectively prevent motor overheating
- One button operation is easy to use,automatic pressure relief
- Battery upgrade to 5.0 AH,two batteries can work in turn
- Special suitcase is clean and tidy inside,it is easy to carry
- The dies are made of high strength alloy steel,after heat treatment,it is durable and beautiful

Model	HL-630B
Output Force:	200KN
Stroke:	63mm
Crimping Range:	CU25-630mm ²
Battery:	18V DC 5.0Ah Li-ion
Charging time:	Approx. 2 hours
Voltage of charger:	110-240V AC
Crimping dies:	25,35,50,70,95,120,150,185, 240,300,400, 500,630mm ²
Machine weight:	8.3KG
Packing:	Plastic Case

HZT-300**ELECTRIC BATTERY
POWERED CRIMPING TOOL**

- The head can be rotate 360° to adapt to different working situations
- The dies are made of high strength alloy steel, after heat treatment, it is durable and beautiful
- High strength of forging, heat treatment
- Good design cooling system can effectively prevent motor overheating
- Battery upgrade to 5.0 AH, two batteries can work in turn
- Special suitcase is clean and tidy inside, it is easy to carry
- The dies are made of high strength alloy steel, after heat treatment, it is durable and beautiful

Model	HZT-300
Output Force:	50KN
Stroke:	17mm
Crimping Range:	CU10-300mm ²
Battery:	18V DC 4.0Ah Li-ion
Charging time:	Approx. 0.5 hours
Voltage of charger:	110-240V AC
Crimping dies:	10,16,25,35,50,70,95,120,150,185,240,300mm ²
Machine weight:	3.26KG
Packing:	Plastic Case

HZT-300C**BATTERY POWERED
CRIMPING AND
CUTTING TOOL**

- 360° rotary head, working at any site
- At the same time with scissors head and pressure joint, realize one machine dual use
- Pistol type tool body design for better balance and easy handling
- Double piston pump and powerful motor ensure quick crimping
- Automatically fully retract ram and stop motor when complete crimp
- LED illuminate work area & low battery charges or lacking pressure, an acoustic signal sounds and led flash
- Li-ion battery with high capacity and require short charging time

Model	HZT-300C
Output Force:	42KN
Stroke:	25mm
Crimping Range:	Max φ30mm(Cu/Al cable,ACSR,wire rope)
Battery:	18V DC 2.0Ah Li-ion
Charging time:	Approx. 2 hours
Voltage of charger:	110-240V AC
Crimping dies:	10,16,25,35,50,70,95,120,150,185,240,300 mm ²
Machine weight:	2.58kgs(Excluding head and battery)
Packing:	Plastic Case

HL-50XBattery Powered
Crimping Tool

- Simple and safe: one-button operating concept for controlling all tool functions
- Electronic control with locking function monitors full closing of the dies
- Simple and safe: automatic retraction when operation is complete
- Manual retract as required
- Motor stall protection
- Ergonomic 2C housing in the Klauke "In-line Design"
- Fastening eye for use with balancer or as fall protection in field applications
- Very low weight and high speed for maximum efficiency
- Powerful drive technology for fatigue proof operations

Model	HL-50X
Output Force:	16KN
Crimping Range:	1) 0.5-50mm ² (TG-JT type is tubular pre-insulated terminal) 2) 0.5-10mm ² (TO.TU type is round, fork-shaped bare terminal) 3) 0.5-6mm ² (TO-JTK TU-JTK type round, fork-shaped pre-insulated terminal) 4) 0.5-6mm ² (SCT-D open barrel 0.5-6mm ²) 5) 1-10mm ² ordinary hexagon
Battery:	18V/2.0Ah Li-Ion
Charging time:	Approx. 1.5 hours

CW-1632

Manual Crimping Tool

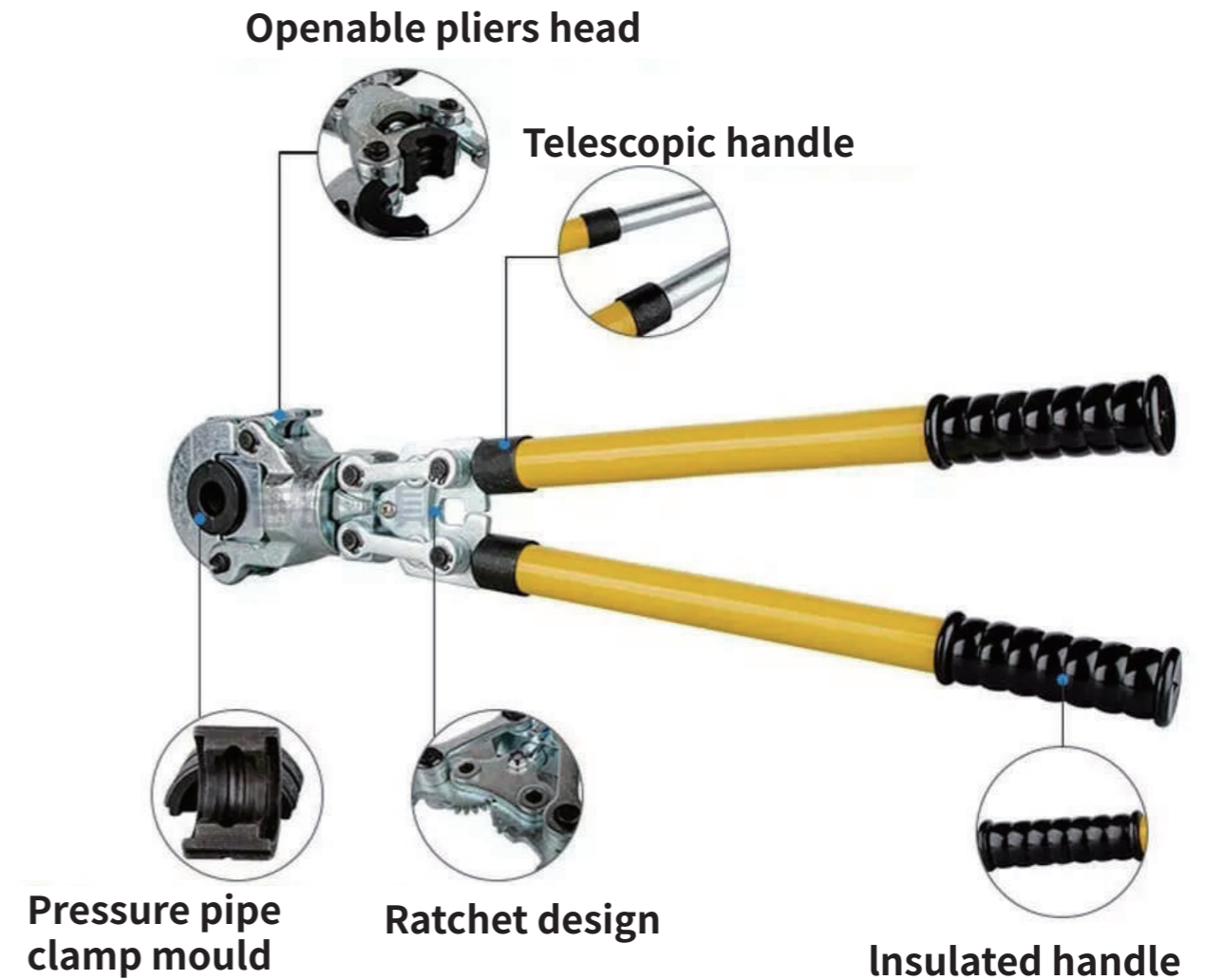

- The handle length is 360mm, which can be extended to 530mm, which is more labor-saving.
- The handle is rotated outward and pulled back to extend the handle. Rotating inside can lock the handle length.
- Suitable for crimping of aluminum plastic pipe, PEX pipe, PB pipe and copper pipe fittings, the pressure joint can be rotated 360degrees freely.

Model	CW-1632
Crimping force:	60KN
Stroke:	16mm
Crimping range:	Max φ16-32mm
Length:	580mm
Product net weight:	6300g
Product gross weight:	6500g
Packing size:	230*80*610mm
Material:	Tool steel
Package:	Plastic Case

HL-60UNV

BATTERY POWERED
CRIMPING TOOL





- C-shape head can be rotate 360° to adapt to different working situations
- Good design cooling system can effectively prevent motor overheating
- One button operation is easy to use, automatic pressure relief
- Battery upgrade to 5.0AH, two batteries can work in turn
- Special suitcase is clean and tidy inside, it is easy to carry
- The dies are made of high strength alloy steel, after heat treatment, it is durable and beautiful
- Easy to carry by hand and tidy inside

Model	HL-60UNV
Output Force:	60KN
Stroke:	42mm
Cutting range:	MaxΦ40mm Cu/AL cable
Battery:	18V DC 5.0Ah Li-ion
Charging time:	Approx. 2 hours
Voltage of charger:	110-240V AC
Crimping dies:	10-300mm ²
Machine weight:	13KG
Packing:	Plastic Case

MULTI-FUNCTIONAL

CRIMPING,CUTTING AND PUNCHING WITH ONE SINGLE TOOL

Adapter	Application:For crimping
	<p>Cu compression cable lugs and compression joints 16-300mm²</p> <p>Al compression cable lugs and compression joints 10-240mm²</p>
Blade	Application: For cutting
	Φ40mm Cu/Al cable and Armored cable
Adapter	Application:For punching
	22.5-61.5mm Round dies.for 3.5 mm mild steel punching

HL-300PRO

BATTERY POWERED CRIMPING TOOL



HL-400PRO

BATTERY POWERED CRIMPING TOOL



- 360° flip-top latch crimping head, working at any site
- Pistol type tool body design for better balance and easy handling
- Double Piston pump and powerful motor ensure quick crimp
- Automatically fully retract ram and stop motor when complete crimp
- Manually retract ram in case of need
- Li-ion battery with high capacity and require short charging time
- A temperature sensor makes the tool stop working automatically when the temperature over 60° under long time working

Model	HL-300B
Output Force:	60KN
Stroke:	17mm
Crimping range:	CU10-300mm ²
Battery:	18v DC 5.0Ah Li-ion
Charging time:	Approx. 2 hours
Voltage of charger:	110-240V AC
Crimping dies:	10,16,25,35,50,70,95,120,150,185,240,300mm ²
Machine weight:	4.0KG
Packing:	Plastic Case

- C-shape head can be rotate 360° to adapt to different working situations
- Good design cooling system can effectively prevent motor overheating
- One button operation is easy to use, automatic pressure relief
- Battery upgrade to 5.0AH, two batteries can work in turn
- Special suitcase is clean and tidy inside, it is easy to carry
- The dies are made of high strength alloy steel, after heat treatment, it is durable and beautiful
- Easy to carry by hand and tidy inside

Model	HL-400B
Output Force:	120KN
Stroke:	42mm
Crimping Range:	CU16-400mm ²
Battery:	18V DC 5.0Ah Li-ion
Charging time:	Approx. 2 hours
Voltage of charger:	110-240V AC
Crimping dies:	16,25,35,50,70,95,120,150,185,240,300,400mm ²
Machine weight:	6.2KG
Packing:	Plastic Case

BATTERY POWERED CABLE CUTTER

SERIES

HL-30B

BATTERY POWERED
CABLE CUTTER



- Head rotates 360°
- Manual retract button
- White LED illuminate work area
- Trigger switch
- Ergonomic design for one hand operation
- Low battery charges or lacking pressure, an acoustic signal sounds and LED flash
- Li-ion battery with high capacity

- The tool is equipped with a double piston pump which characterized with a fast approach towards the connecting material and transfer to high pressure automatically by slow crimping
- If a deviation from the set operation pressure or low battery charges is identified, an acoustic signal sounds and a red display flashes.
- One key control-press the trigger to start
- working, half losing the trigger means stop forcing pressure, losing fully means piston
- return to the original position

Model	HL-30B
Output Force:	60KN
Stroke:	21mm
Crimping Range:	MaxΦ30mm (Cu/AL cable, ACSR)
Battery:	18V DC 5.0Ah Li-ion
Charging time:	90min
Voltage of charger:	110-240V AC
Machine weight:	4.0KG
Packing:	Plastic Case



BATTERY POWERED
CABLE CUTTER

www.hewlee.com

HL-45B

BATTERY POWERED CABLE CUTTER



- 360° flip-top latch crimping head, working at any site
- Pistol type tool body design for better balance and easy handling
- Double Piston pump and powerful motor ensure quick crimp
- Automatically fully retract ram and stop motor when complete crimp
- Manually retract ram in case of need
- Li-ion battery with high capacity and require short charging time
- A temperature sensor makes the tool stop working automatically when the temperature over 60° under long time working

Model	HL-45B
Output Force:	60KN
Stroke:	45mm
Crimping Range:	maxΦ45mm Cu/Al cable
Battery:	18v DC5.0Ah Li-ion
Charging time:	90min
Voltage of charger:	110-240V AC
Machine weight:	5.5KG
Packing:	Plastic Case

HL-55B

BATTERY POWERED CABLE CUTTER



Replaceable Blade, easy to replace

Model	HL-55B
Output Force:	120KN
Stroke:	50mm
Crimping Range:	maxΦ55mm Cu/Al cable
Battery:	18v DC5.0Ah Li-ion
Charging time:	90min
Voltage of charger:	110-240V AC
Machine weight:	6.72KG
Packing:	Plastic Case



HL-85B

BATTERY POWERED CABLE CUTTER



Pin, For locking the cutting head

Model	HL-85B
Output Force:	60KN
Stroke:	85mm
Crimping Range:	maxΦ70mm Cu/Al cable
Battery:	18v DC5.0Ah Li-ion
Charging time:	90min
Voltage of charger:	110-240V AC
Machine weight:	7.96KG
Packing:	Plastic Case

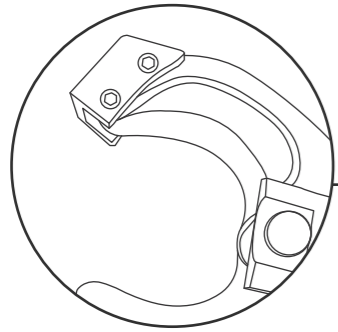

HL-65BBATTERY POWERED
CABLE CUTTER

- New high-strength blade, improve the life of the blade

MODEL	HL-65B
Output Force:	120KN
Stroke:	50mm
Crimping Range:	MaxΦ60mm Cu/Al cable
Battery:	18v DC5.0Ah Li-ion
Charging time:	90min
Voltage of charger:	110-240V AC
Machine weight:	5.7KG
Packing:	Plastic Case

**HL-85B**BATTERY POWERED
CABLE CUTTER

- Pin, For locking the cutting head

MODEL	HL-85B
Output Force:	120KN
Stroke:	45mm
Crimping Range:	MaxΦ85mm Cu/Al cable
Battery:	18v DC5.0Ah Li-ion
Charging time:	90min
Voltage of charger:	110-240V AC
Machine weight:	6.86KG
Packing:	Plastic Case

**HL-105B**OPENED TYPE BATTERY
POWERED CABLE CUTTER

- Scissors type, cable directly into the scissors mouth, no need to open and close tools

MODEL	HL-105B
Output Force:	250KN
Stroke:	45mm
Crimping Range:	MaxΦ105mm Cu/Al cable
Battery:	18v DC5.0Ah Li-ion
Charging time:	90min
Voltage of charger:	110-240V AC
Machine weight:	9.35KG
Packing:	Plastic Case

**HL-120B**BATTERY RATCHET
CABLE CUTTER

- Both blades are identical and easy to replace

MODEL	HL-120B
Output Force:	250KN
Stroke:	62mm
Crimping Range:	MaxΦ110mm Cu/Al cable
Battery:	18v DC5.0Ah Li-ion
Charging time:	90min
Voltage of charger:	110-240V AC
Machine weight:	12.22KG
Packing:	Plastic Case



HL-50M

BATTERY RATCHET
CABLE CUTTER



- Copper-aluminum cable and ACSR cable can be cut off
- The blade is made of alloy steel, after forging and special heat treatment, it can withstand long time of strenuous work
- Reasonable structure, light weight, labor-saving, easy to carry and operate.
- Large cutting range, light weight, easy to operate
- Ergonomic handle fits the curve of the hand for comfortable grip. It is easy to operate with switch on the handle.

MODEL	HL-50M
Crimping Range	Max Φ 50mm for Cu/Al cable
	Max 800sqmm for ACSR;
	Max 100sqmm for Prestressed steel wire
Battery:	18v DC4.0Ah Li-ion
Charging time:	1.5 hour
Voltage of charger:	110-240V AC
Cutting/charge:	80-100 times
Packing:	Plastic Case

HL-MM36B

BATTERY POWERED
NUT SPLITTER



- Turn-over type 360° degree breaking cutting head
- Electric control and breaking operation monitoring
- Soft packing ergonomic double component plastic shell, single hand operation, comfortable and safe
- Automatic return reset stop(ARS) is used for positioning control in multiple operations
- Automatically return to reset after completion of operation(manual return to reset if necessary)
- High strength durable switch key, continuous opening and closing of durable test switch for ten s
- of thousands of times before leaving the factory

MODEL	HL-MM36
Output Force:	120KN
Stroke:	32mm
Crimping Range:	M8-M24: Long blade head M8-M14
	Mid blade head M14-M20
	Short blade head M18-M24
Battery:	18V DC 5.0Ah Li-ion
Charging time:	2 hour
Voltage of charger:	110-240V AC
Machine weight:	6.5KG
Packing:	Plastic Case

BATTERY PIPE CRIMPING TOOL

SERIES

HL-1550B

BATTERY PIPE CRIMPING TOOL



- Rotatable head design for easy pipe insertion, dies installation and also flexible operation in confined place
- Interchangeable dies ensure precise crimping for different pipes
- Powerful motor for quick and efficient crimping
- High-performance li-ion battery with high capacity and require short charging time
- Auto-retract function on for safe and precise crimping
- Make dies retract with ram once complete crimping
- Pressure can hold even if release switch, allow operator stop to check or adjust at any time during operation
- Pistol type tool body design for better balance and easy handling by hand
- Plastic case package for easy carrying and well tools protection

Model	HL-1550B
Output Force:	42KN
Pressing Range:	steel pipe, Copper pipe, PEX-pipe, XPAP, Multilayer pipe
Battery:	18V DC 5.0Ah Li-ion
Charging time:	2 hours
Voltage of charger:	110-240V AC
Machine weight:	4.0KG
Packing:	Plastic Case



HZT-25**BATTERY PIPE
CRIMPING TOOL**

- Latch type 360degree rotatable head for easy pipe insertion and flexible operation
- Several sets interchangeable crimping dies ensure precise crimping for different pipes
- Stick type compact tool body design for easy handling and carrying by hand
- Powerful motor ensure quick and efficient pipe crimping
- High-performance Li-ion battery with high capacity and require short charging time
- LED illuminate working area foreasy operation in dark area
- Auto-retract function ensure precise and safe operation
- Plastic case package for easy carrying and well tool protection

Model	HZT-25
Output Force:	42KN
Pressing Range:	15-25mmsteel pipe,Copper pipe, PEX, pipe,XPAP,Multilayer pipe
Battery:	18V DC 4.0Ah Li-ion
Charging time:	2 hours
Voltage of charger:	110-240V AC
Machine weight:	4.0KG
Packing:	Plastic Box

HZT-50**BATTERY PIPE
CRIMPING TOOL**

- Latch type 360degree rotatable head for easy pipe insertion and flexible operation
- Several sets interchangeable crimping dies ensure precise crimping for different pipes
- Stick type compact tool body design for easy handling and carrying by hand
- Powerful motor ensure quick and efficient pipe crimping
- High-performance Li-ion battery with high capacity and require short charging time
- LED illuminate working area foreasy operation in dark area
- Auto-retract function ensure precise and safe operation
- Plastic case package for easy carrying and well tool protection

Model	HZT-50
Output Force:	42KN
Pressing Range:	15-54mmsteel pipe,Copper pipe, PEX,pipe,XPAP,Multilayer pipe
Battery:	18V DC 4.0Ah Li-ion
Charging time:	2 hours
Voltage of charger:	110-240V AC
Machine weight:	4.0KG
Packing:	Plastic Box

PLUG CRIMPING TOOL Q series



HL-400Q

ELECTRIC CRIMPING TOOL



- Unique patented design, plug-in use. 360° flip-top latch crimping head, working at any site
- Fast speed, automatic oil return.
- Adopt low-power high-voltage DC motor, which is more energy-saving and environmentally friendly, with larger output power.
- Lower noise, lighter weight, and easier to carry and work than traditional series-connected motors.
- Over-current protection function, when the machine is blocked or short-circuited, it will automatically cut off the power.

Model	HL-400Q
Voltage:	220V
Output Force:	120KN
Stroke:	42mm
Crimping Range:	CU16-400mm ²
Crimping dies:	16,25,35,50,70,95,120,150,185,240,300,400mm ²
Machine weight:	6.4KG
Packing:	Plastic Case

HEWLEE



HEWLEE

ELECTRIC CRIMPING TOOL

www.hewlee.com

HL-300Q

ELECTRIC CRIMPING TOOL

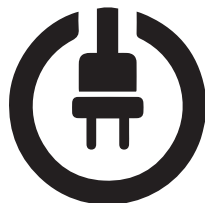

- Unique patented design, plug-in use. 360° flip-top latch crimping head, working at any site
- Fast speed, automatic oil return.
- Adopt low-power high-voltage DC motor, which is more energy-saving and environmentally friendly, with larger output power.
- Lower noise, lighter weight, and easier to carry and work than traditional series-connected motors.
- Over-current protection function, when the machine is blocked or short-circuited, it will automatically cut off the power.

Model	HL-300Q
Voltage:	220V
Output Force:	60KN
Stroke:	17mm
Crimping Range:	CU10-300mm ²
Crimping dies:	10,16,25,35,50,70,95,120,150,185,240,300mm ²
Machine weight:	4.2KG
Packing:	Plastic Case

HL-45Q

ELECTRIC CABLE CUTTER

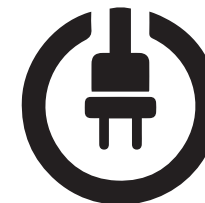
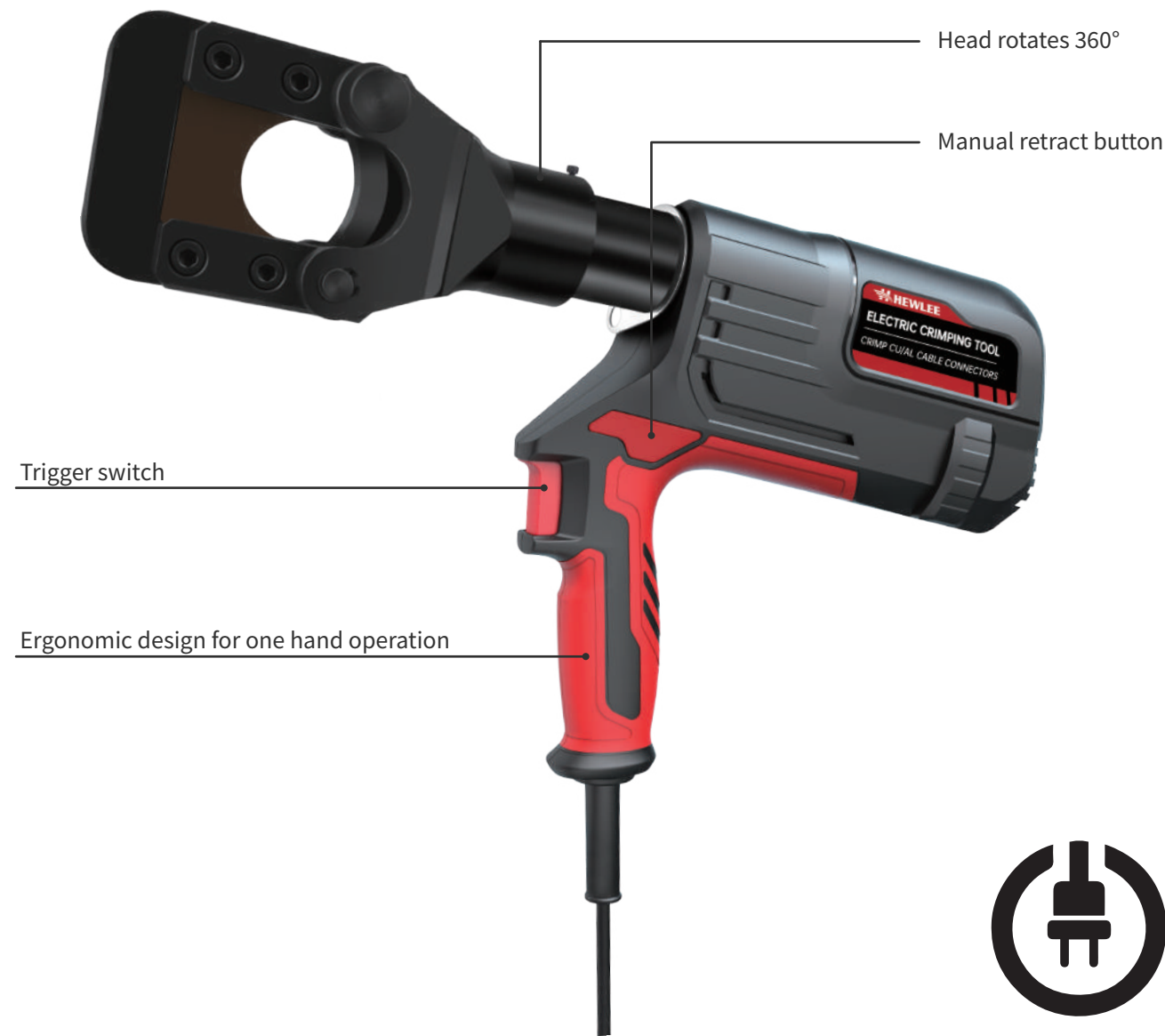

- Unique patented design, plug-in use. 360° flip-top latch crimping head, working at any site
- Fast speed, automatic oil return.
- Adopt low-power high-voltage DC motor, which is more energy-saving and environmentally friendly, with larger output power.
- Lower noise, lighter weight, and easier to carry and work than traditional series-connected motors.
- Over-current protection function, when the machine is blocked or short-circuited, it will automatically cut off the power.

Model	HL-45Q
Voltage:	220V
Output Force:	60KN
Stroke:	45mm
Crimping Cutting:	MaxΦ45mm Cu/Al cable
Machine weight:	5.7KG
Packing:	Plastic Case

HL-1550Q

ELECTRIC PIPE PRESS TOOL

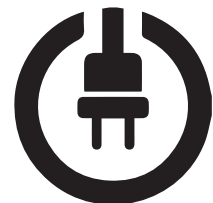
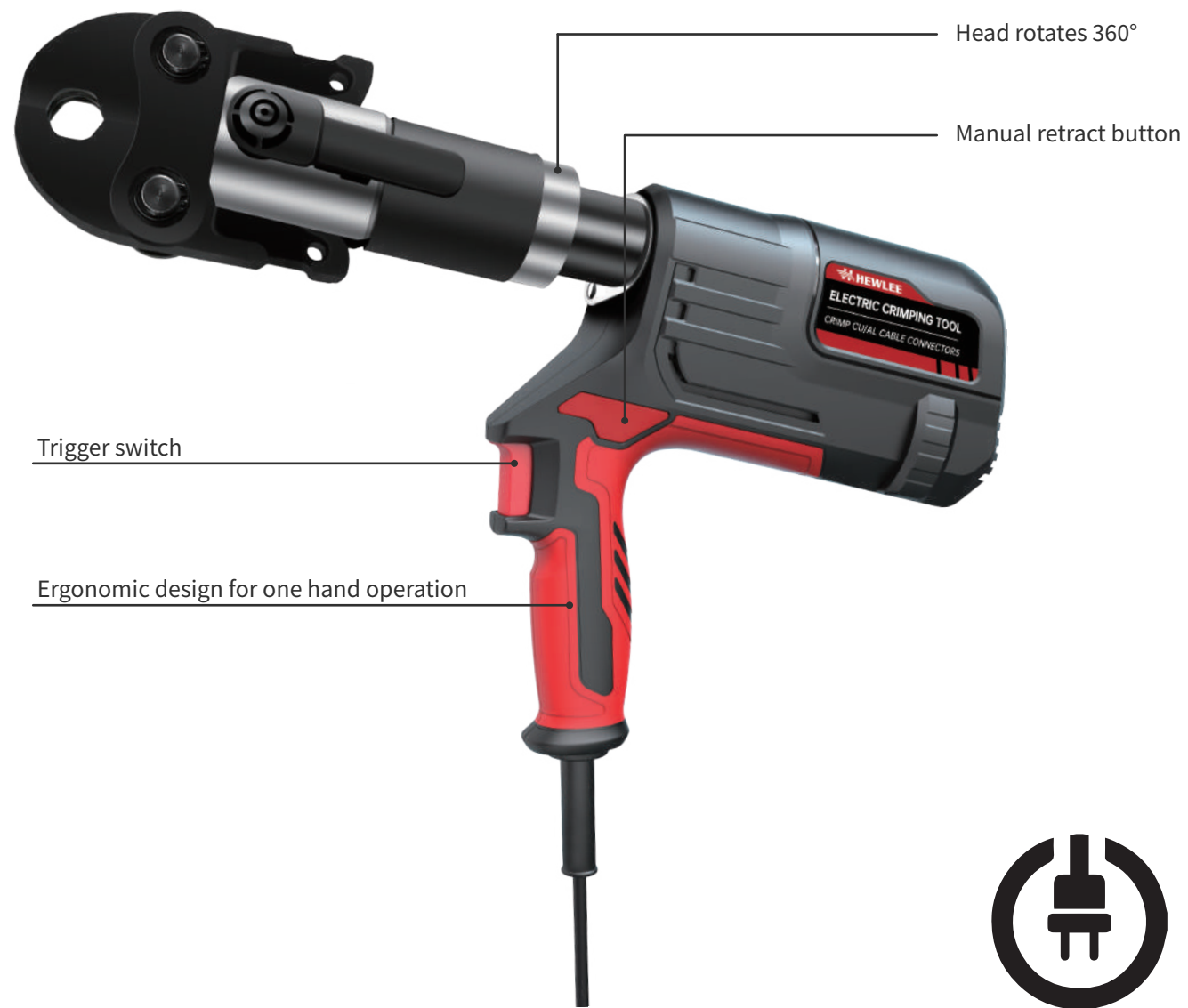

HZT-25Q

ELECTRIC PIPE PRESS TOOL



Crimping head

Cut Head

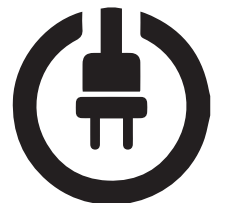

- Unique patented design, plug-in use. 360° flip-top latch crimping head, working at any site
- Fast speed, automatic oil return.
- Adopt low-power high-voltage DC motor, which is more energy-saving and environmentally friendly, with larger output power.
- Lower noise, lighter weight, and easier to carry and work than traditional series-connected motors.
- Over-current protection function, when the machine is blocked or short-circuited, it will automatically cut off the power.

Model	HL-1550Q
Voltage:	220V
Output Force:	60KN
Stroke:	45mm
Crimping Range:	CU15-50mm
Crimping dies:	15, 20, 25, 32, 40, 50mm
Machine weight:	4.25KG
Packing:	Plastic Case

- Unique patented design, plug-in use. 360° flip-top latch crimping head, working at any site
- Fast speed, automatic oil return.
- Adopt low-power high-voltage DC motor, which is more energy-saving and environmentally friendly, with larger output power.
- Lower noise, lighter weight, and easier to carry and work than traditional series-connected motors.
- Over-current protection function, when the machine is blocked or short-circuited, it will automatically cut off the power.

Model	HZT-25Q
Voltage:	220V
Output Force:	60KN
Stroke:	40mm
Crimping Range:	CU10-300mm ²
Crimping Cutting:	Max φ30mm(Cu/Al cable)
Crimping dies:	10,16,25,35,50,70,95,120,150,185,240,300mm ²
Machine weight:	3.66KG
Packing:	Plastic Case

PLUG CRIMPING TOOL

Q series



HL-400T

ELECTRIC CRIMPING TOOL



- Unique patented design, plug-in use. 360° flip-top latch crimping head, working at any site
- Fast speed, automatic oil return.
- Adopt low-power high-voltage DC motor, which is more energy-saving and environmentally friendly, with larger output power.
- Lower noise, lighter weight, and easier to carry and work than traditional series-connected motors.
- Over-current protection function, when the machine is blocked or short-circuited, it will automatically cut off the power.

Model	HL-400T
Voltage:	220V
Output Force:	120KN
Stroke:	42mm
Crimping Range:	CU16-400mm ²
Crimping dies:	16,25,35,50,70,95,120,150,185,240,300,400mm ²
Machine weight:	6.7KG
Packing:	Plastic Case

HEWLEE



HEWLEE

ELECTRIC CRIMPING TOOL

www.hewlee.com

HL-300T

ELECTRIC CRIMPING TOOL

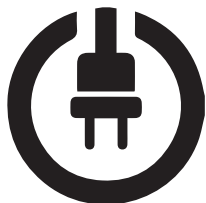

- Unique patented design, plug-in use. 360° flip-top latch crimping head, working at any site
- Fast speed, automatic oil return.
- Adopt low-power high-voltage DC motor, which is more energy-saving and environmentally friendly, with larger output power.
- Lower noise, lighter weight, and easier to carry and work than traditional series-connected motors.
- Over-current protection function, when the machine is blocked or short-circuited, it will automatically cut off the power.

Model	HL-300T
Voltage:	220V
Output Force:	60KN
Stroke:	17mm
Crimping Range:	CU10-300mm ²
Crimping dies:	10,16,25,35,50,70,95,120,150,185,240,300mm ²
Machine weight:	4.45KG
Packing:	Plastic Case

HL-45T

ELECTRIC CABLE CUTTER

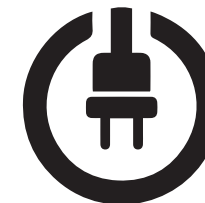
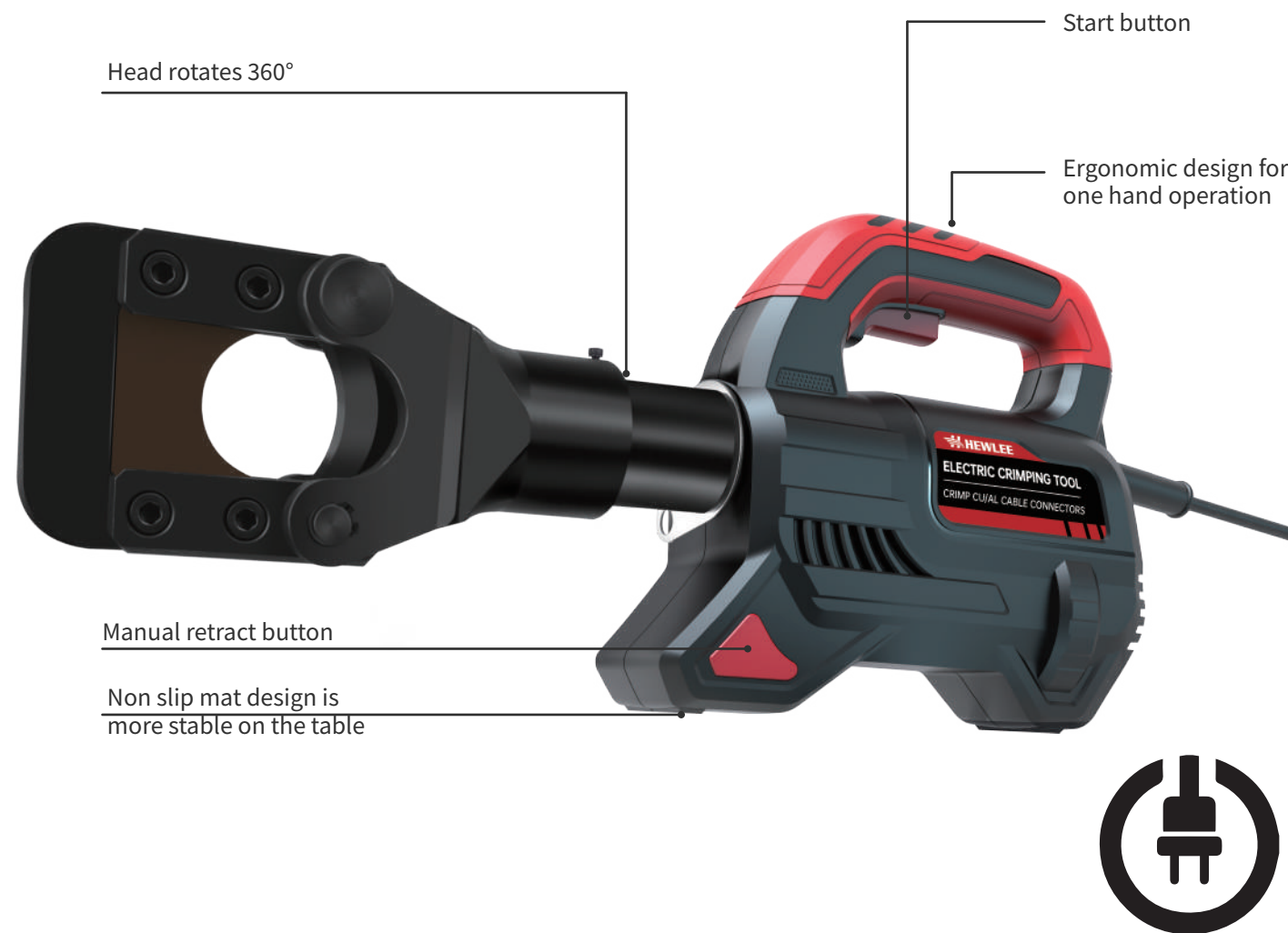

- Unique patented design, plug-in use. 360° flip-top latch crimping head, working at any site
- Fast speed, automatic oil return.
- Adopt low-power high-voltage DC motor, which is more energy-saving and environmentally friendly, with larger output power.
- Lower noise, lighter weight, and easier to carry and work than traditional series-connected motors.
- Over-current protection function, when the machine is blocked or short-circuited, it will automatically cut off the power.

Model	HL-45T
Voltage:	220V
Output Force:	60KN
Stroke:	45mm
Crimping Cutting:	MaxΦ45mm Cu/Al cable
Machine weight:	5.75KG
Packing:	Plastic Case

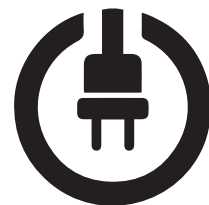
HL-1550TELECTRIC PIPE
PRESS TOOL

- Unique patented design, plug-in use. 360° flip-top latch crimping head, working at any site
- Fast speed, automatic oil return.
- Adopt low-power high-voltage DC motor, which is more energy-saving and environmentally friendly, with larger output power.
- Lower noise, lighter weight, and easier to carry and work than traditional series-connected motors.
- Over-current protection function, when the machine is blocked or short-circuited, it will automatically cut off the power.

Model	HL-1550T
Voltage:	220V
Output Force:	60KN
Stroke:	45mm
Crimping Range:	CU15-50mm
Crimping dies:	15, 20, 25, 32, 40, 50mm
Machine weight:	4.3KG
Packing:	Plastic Case

HZT-25TELECTRIC PIPE
PRESS TOOL

Crimping Head



Cutting Head

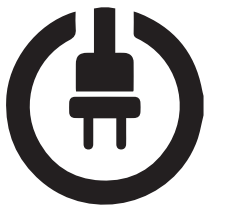

- Unique patented design, plug-in use. 360° flip-top latch crimping head, working at any site
- Fast speed, automatic oil return.
- Adopt low-power high-voltage DC motor, which is more energy-saving and environmentally friendly, with larger output power.
- Lower noise, lighter weight, and easier to carry and work than traditional series-connected motors.
- Over-current protection function, when the machine is blocked or short-circuited, it will automatically cut off the power.

Model	HZT-25T
Voltage:	220V
Output Force:	60KN
Stroke:	40mm
Crimping Range:	CU10-300mm ²
Crimping Cutting:	Max ϕ 30mm(Cu/Al cable)
Crimping dies:	10,16,25,35,50,70,95,120,150,185,240,300mm ²
Machine weight:	3.76KG
Packing:	Plastic Case